

### SITEPLAN

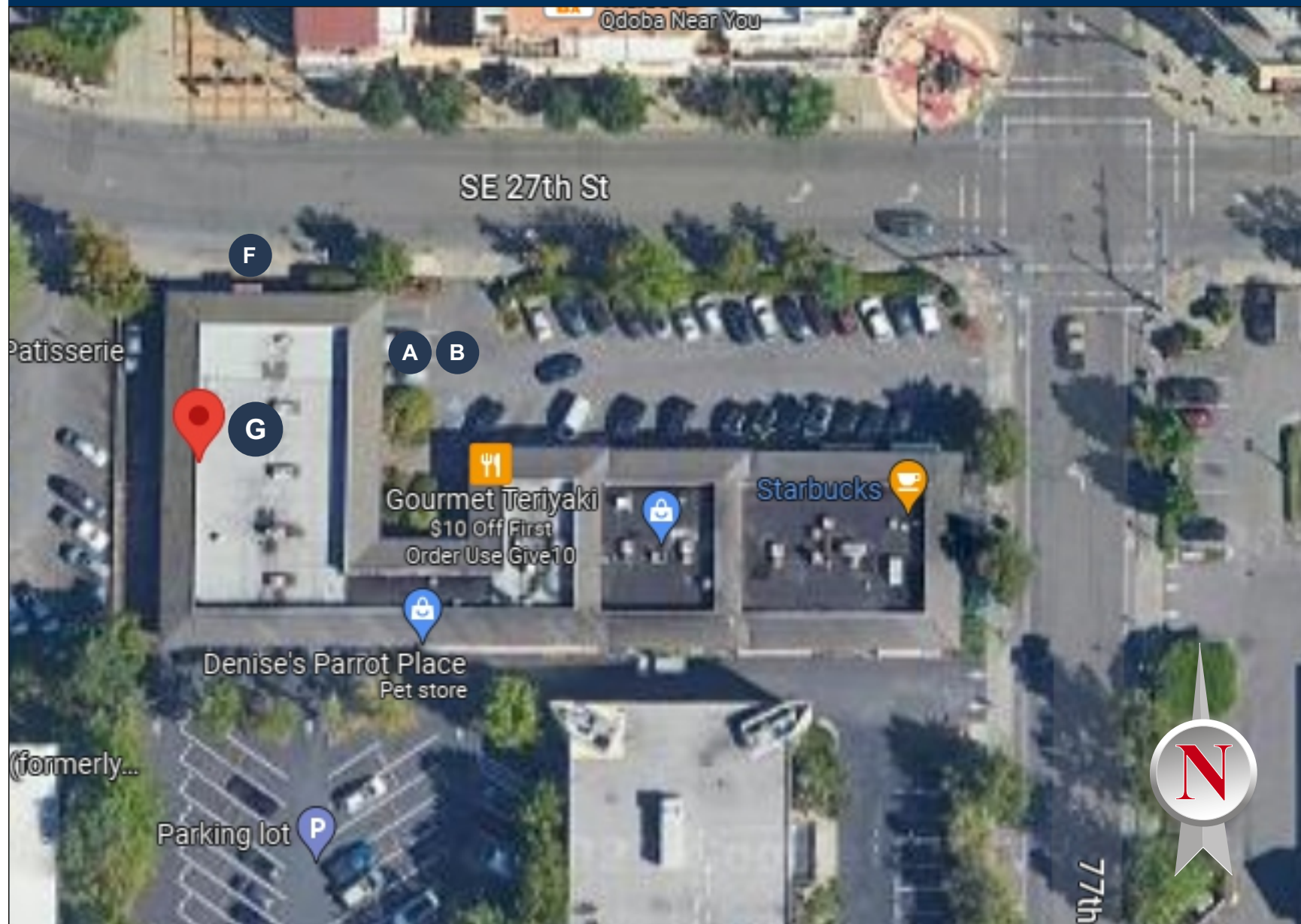

N.T.S.

### WORK SCOPE

- A** CL-2-P FACE-LIT LINEAR CHANNEL LETTERS
- B** SDV DOUBLE DOOR VINYL
- F** ATM SURROUND-BY OTHERS
- G** INTERIOR - FLAT CUT OUT LETTERS

**COAST SIGN**  
1500 W. Embassy St. Anaheim, CA 92802 714.520.9144

Date: 09-25-2023	Project Name: WaFd Bank	Sit ID: Mercer Island
Scale: NTS	Address: 7633 SE 27TH ST	
Drawn: ER	City / State / Zip: MERCER ISLAND, WA	
PM: NC	Notes:	

This is an original unpublished drawing created by Coast Sign, Inc. It is submitted for your personal use in conjunction with a project being planned for you by Coast Sign, Inc., And shall not be reproduced, used by or disclosed to any firm or corporation for any purpose whatsoever without written permission.

No.	Designer	Date	Revision Notes	No.	Designer	Date	Revision Notes
13	JU	09-29-25	Add Raceway to Sign A, Relocate C, Added Sign H	7		01-07-25	Updated Parking Sign
16	IA	10-20-25	Update BB as per request	8	ER	08-21-25	Change Photo Sign C and E
17	WA	11-19-25	Update sign C & F	9	JU	08-26-25	Add ATM Surround to Brand Book
18	JU	11-26-25	Deleted Sign C from Brand Book	10	JU	09-09-25	Remove D, C no Rw, replace photo page 4
5				11	EA	09-23-25	Removed C added sign G
6				12	ER	09-25-25	Add Sign G

**DESIGN DRAWING 1 of 8**

Request Number:

**PRJ-WAFD-183240-R18**

**EXISTING PHOTO- SIGN A**



**PHOTO ENHANCEMENT - SIGN A**



**CONCEPTUAL IMAGE ONLY. FIELD VERIFY DIMENSIONS PRIOR TO MANUFACTURE**

**COAST SIGN**  
1500 W. Embassy St. Anaheim, CA 92802 714.520.9144

Date: 09-25-2023	Project Name: WaFd Bank	Sit ID: Mercer Island
Scale: NTS	Address: 7633 SE 27TH ST	
Drawn: ER	City / State / Zip: MERCER ISLAND, WA	
PM: NC	Notes:	

This is an original unpublished drawing created by Coast Sign, Inc. It is submitted for your personal use in conjunction with a project being planned for you by Coast Sign, Inc., And shall not be reproduced, used by or disclosed to any firm or corporation for any purpose whatsoever without written permission.

No.	Designer	Date	Revision Notes	No.	Designer	Date	Revision Notes
13	JU	09-29-25	Add Raceway to Sign A, Relocate C, Added Sign H	7		01-07-25	Updated Parking Sign
16	IA	10-20-25	Update BB as per request	8	ER	08-21-25	Change Photo Sign C and E
17	WA	11.19.25	Update sign C & F	9	JU	08-26-25	Add ATM Surround to Brand Book
18	JU	11-26-25	Deleted Sign C from Brand Book	10	JU	09-09-25	Remove D, C no Rw, replace photo page 4
5				11	EA	09-23-25	Removed C added sign G
6				12	ER	09-25-25	Add Sign G

**DESIGN DRAWING 2 of 8**

Request Number:

**PRJ-WAFD-183240-R18**

**EXISTING PHOTO - SIGN B**



**PHOTO ENHANCEMENT - SIGN B**



**COAST SIGN**  
1500 W. Embassy St. Anaheim, CA 92802 714.520.9144

Date: 09-25-2023	Project Name: WaFd Bank	Sit ID: Mercer Island
Scale: NTS	Address: 7633 SE 27TH ST	
Drawn: ER	City / State / Zip: MERCER ISLAND, WA	
PM: NC	Notes:	

This is an original unpublished drawing created by Coast Sign, Inc. It is submitted for your personal use in conjunction with a project being planned for you by Coast Sign, Inc., And shall not be reproduced, used by or disclosed to any firm or corporation for any purpose whatsoever without written permission.

No.	Designer	Date	Revision Notes	No.	Designer	Date	Revision Notes
13	JU	09-29-25	Add Raceway to Sign A, Relocate C, Added Sign H	7		01-07-25	Updated Parking Sign
16	IA	10-20-25	Update BB as per request	8	ER	08-21-25	Change Photo Sign C and E
17	WA	11.19.25	Update sign C & F	9	JU	08-26-25	Add ATM Surround to Brand Book
18	JU	11-26-25	Deleted Sign C from Brand Book	10	JU	09-09-25	Remove D, C no Rw, replace photo page 4
5				11	EA	09-23-25	Removed C added sign G
6				12	ER	09-25-25	Add Sign G

**DESIGN DRAWING 3 of 8**

Request Number:

**PRJ-WAFD-183240-R18**

**EXISTING PHOTO - SIGN F**



**NOTE: SIGN F BY OTHERS**

**CONCEPTUAL IMAGE ONLY. FIELD VERIFY DIMENSIONS PRIOR TO MANUFACTURE**

**PHOTO ENHANCEMENT - SIGN F**



**COAST SIGN**  
1500 W. Embassy St. Anaheim, CA 92802 714.520.9144

Date: 09-25-2023	Project Name: WaFd Bank	Sit ID: Mercer Island
Scale: NTS	Address: 7633 SE 27TH ST	
Drawn: ER	City / State / Zip: MERCER ISLAND, WA	
PM: NC	Notes:	

This is an original unpublished drawing created by Coast Sign, Inc. It is submitted for your personal use in conjunction with a project being planned for you by Coast Sign, Inc., And shall not be reproduced, used by or disclosed to any firm or corporation for any purpose whatsoever without written permission.

No.	Designer	Date	Revision Notes	No.	Designer	Date	Revision Notes
13	JU	09-29-25	Add Raceway to Sign A, Relocate C, Added Sign H	7		01-07-25	Updated Parking Sign
16	IA	10-20-25	Update BB as per request	8	ER	08-21-25	Change Photo Sign C and E
17	WA	11.19.25	Update sign C & F	9	JU	08-26-25	Add ATM Surround to Brand Book
18	JU	11-26-25	Deleted Sign C from Brand Book	10	JU	09-09-25	Remove D, C no R.w. replace photo page 4
5				11	EA	09-23-25	Removed C added sign G
6				12	ER	09-25-25	Add Sign G

**DESIGN DRAWING 4 of 8**

Request Number:

**PRJ-WAFD-183240-R18**

**A** CL-0B-P FACE-LIT CHANNEL LETTERS LINEAR LOGO - PREFERRED LOGO

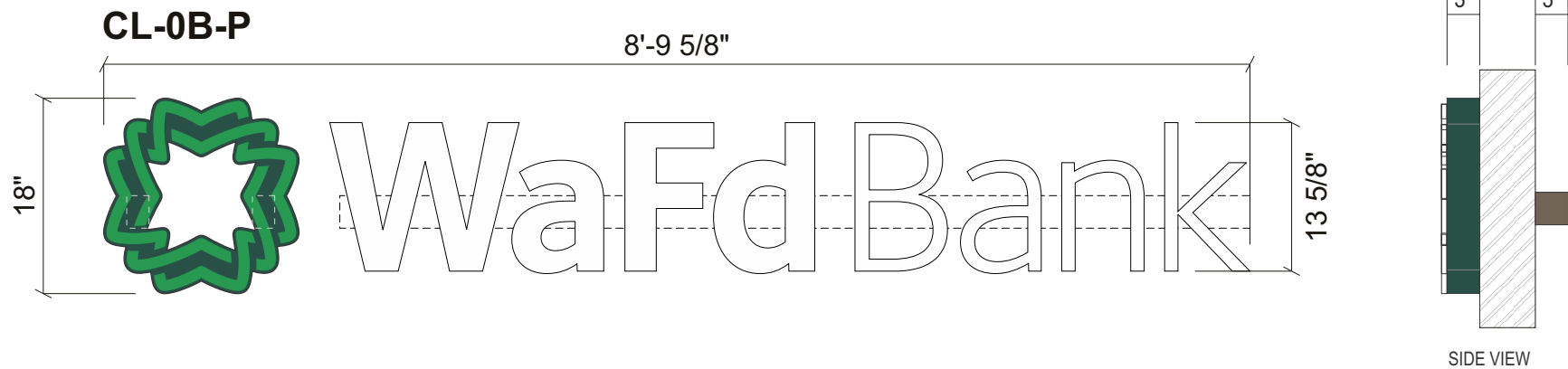

**FACE-LIT CHANNEL LETTERS LINEAR LOGO ON WIREWAY (BEHIND THE WALL)  
FOR ALL WALLS - PREFERRED LOGO**

Additional Details in Engineering Section



**SPECIFICATIONS**

- LOGO: FACE-LIT CHANNEL LETTERS RETURNS **P-1**, ALUM. FACE PAINT **P-1**
- WAFD BANK: FACE LIT TOSH CHANNEL LETTERS RETURNS **P-1**, FACES WHITE
- RACEWAY: **P-2** PAINT SW7040 SMOKE HOUSE

**COLORS/FINISHES**

- P-1** MP TO MATCH PANTONE 3305C
- P-2** SW TO MATCH SW7040 - SMOKE HOUSE
- V-2** TRANSLUCENT TO MATCH PANTONE 356C, VIVID GREEN 3630-156



**NIGHT VIEW**  
SCALE: NTS

**COAST SIGN**  
1500 W. Embassy St. Anaheim, CA 92802 714.520.9144

Date: 09-25-2023	Project Name: WaFd Bank	Sit ID: Mercer Island
Scale: NTS	Address: 7633 SE 27TH ST	
Drawn: ER	City / State / Zip: MERCER ISLAND, WA	
PM: NC	Notes:	

This is an original unpublished drawing created by Coast Sign, Inc. It is submitted for your personal use in conjunction with a project being planned for you by Coast Sign, Inc., And shall not be reproduced, used by or disclosed to any firm or corporation for any purpose whatsoever without written permission.

No.	Designer	Date	Revision Notes	No.	Designer	Date	Revision Notes
13	JU	09-29-25	Add Raceway to Sign A, Relocate C, Added Sign H	7		01-07-25	Updated Parking Sign
16	IA	10-20-25	Update BB as per request	8	ER	08-21-25	Change Photo Sign C and E
17	WA	11-19-25	Update sign C & F	9	JU	08-26-25	Add ATM Surround to Brand Book
18	JU	11-26-25	Deleted Sign C from Brand Book	10	JU	09-09-25	Remove D, C no Rw, replace photo page 4
5				11	EA	09-23-25	Removed C added sign G
6				12	ER	09-25-25	Add Sign G

**DESIGN DRAWING 5 of 8**

Request Number:

**PRJ-WAFD-183240-R18**

**NOTE: STORE HOURS TO BE VERIFIED PRIOR TO PRODUCTION**

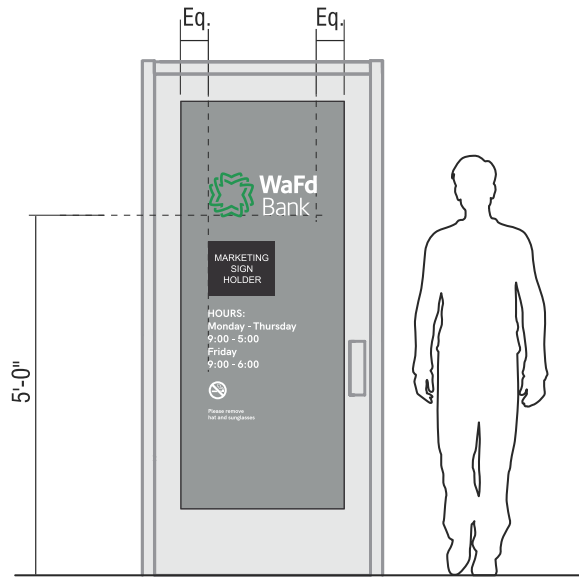

**PROPOSED**  
SCALE: 3/8" = 1'-0"

Total Window Frontage Area = 744.75 ft<sup>2</sup>  
 Total Door Area = 22 ft<sup>2</sup>  
 Total Window Graphic Area = 5.25 ft<sup>2</sup>  
 25% of 22 ft<sup>2</sup> would be 5.5 ft<sup>2</sup>

The window graphics are less than 25% than the Total Door Area.

**SPECIFICATIONS**

- 1. VINYL APPLIED 1ST SURFACE V-1, V-2

**NOTES**

- REMOVE EXISTING VINYL
- CLEAN FACE SURFACES PRIOR TO APPLYING VINYL GRAPHICS
- MARKETING HOLDER PROVIDED BY WAFD, INSTALLED BY COAST SIGN

**COLORS/FINISHES**

- V-1 WHITE
- V-2 TO MATCH PANTONE 356C, VIVID GREEN 3630-156

**FONTS**

- HK GROTESK REGULAR
- HK GROTESK BOLD

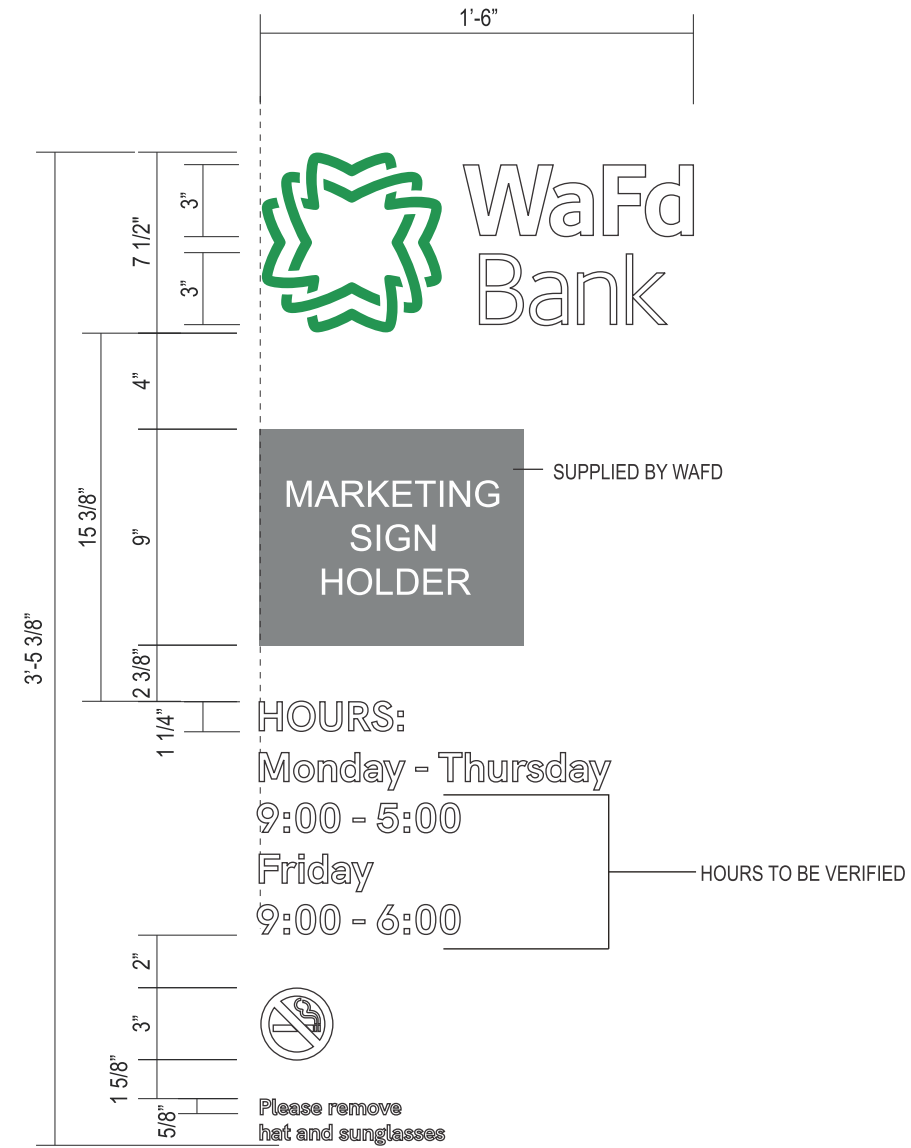

**FRONT VIEW**  
SCALE: 1 1/2" = 1'-0"

Date: 09-25-2023	Project Name: WaFd Bank	Sit ID: Mercer Island
Scale: NTS	Address: 7633 SE 27TH ST	
Drawn: ER	City / State / Zip: MERCER ISLAND, WA	
PM: NC	Notes:	

This is an original unpublished drawing created by Coast Sign, Inc. It is submitted for your personal use in conjunction with a project being planned for you by Coast Sign, Inc., And shall not be reproduced, used by or disclosed to any firm or corporation for any purpose whatsoever without written permission.

No.	Designer	Date	Revision Notes	No.	Designer	Date	Revision Notes
13	JU	09-29-25	Add Raceway to Sign A, Relocate C, Added Sign H	7		01-07-25	Updated Parking Sign
16	IA	10-20-25	Update BB as per request	8	ER	08-21-25	Change Photo Sign C and E
17	WA	11-19-25	Update sign C & F	9	JU	08-26-25	Add ATM Surround to Brand Book
18	JU	11-26-25	Deleted Sign C from Brand Book	10	JU	09-09-25	Remove D, C no Rw, replace photo page 4
5				11	EA	09-23-25	Removed C added sign G
6				12	ER	09-25-25	Add Sign G

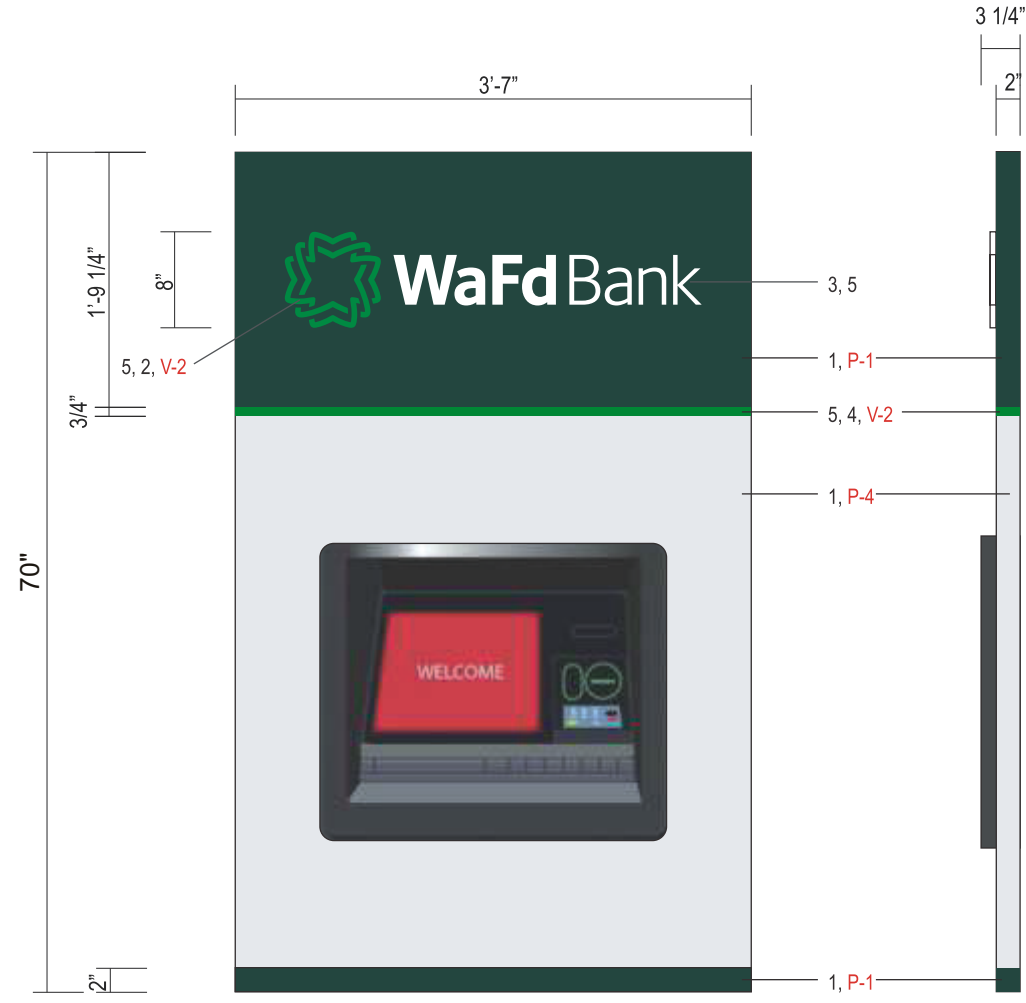

PROPOSED - FRONT VIEW

SIDE VIEW

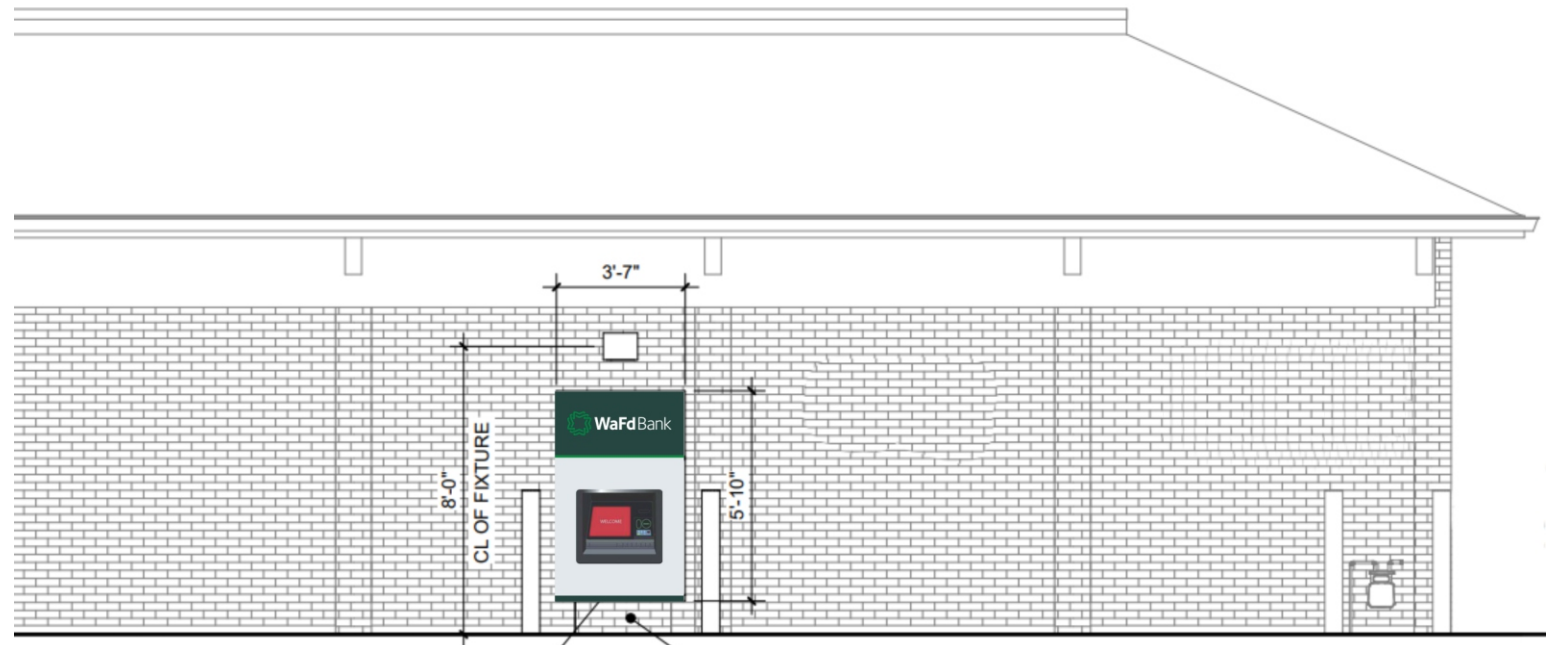

PROPOSED ATM AND SURROUND, F.O.I.O. AT (E) DOORWAY, UNDER SEPARATE PERMIT. ATM TO COMPLY WITH ICC A117.1 SECTION 707

BRICK INFILL TO MATCH EXISTING

PROPOSED ATM SURROUND ELEVATION

SCALE: 3/16"=1'-0"

**F ATM SURROUND**  
SCALE: 1/2"=1'-0"

**SPECIFICATIONS**

1. ALUM. PAN P-1, P-4
2. LOGO: ROUTED W/ 1/2" PUSH THRU W/ TRANSLUCENT VINYL V-2
3. LETTERS: ROUTED W/ 1/2" CLEAR PUSH THRU
4. LIGHTER GREEN BAND (FACE & RETURNS) CLEAR PLASTIC W/ 2ND SURFACE VINYL V-2
5. ILLUMINATED W/ WHITE LEDS

**COLORS/FINISHES**

- P-1 MP TO MATCH PANTONE 3305C GREEN HIGH GLOSS AUTOMOTIVE FINISH
- P-4 MP 00723 GREYBLUE W/ SUEDE ADDITIVE
- V-2 TRANSLUCENT TO MATCH PANTONE 356C, VIVID GREEN 3630-156

**NOTE: SIGN F - ATM SURROUND BY OTHERS**

**COAST SIGN**  
1500 W. Embassy St. Anaheim, CA 92802 714.520.9144

Date: 09-25-2023	Project Name: WaFd Bank	Sit ID: Mercer Island
Scale: NTS	Address: 7633 SE 27TH ST	
Drawn: ER	City / State / Zip: MERCER ISLAND, WA	
PM: NC	Notes:	

This is an original unpublished drawing created by Coast Sign, Inc. It is submitted for your personal use in conjunction with a project being planned for you by Coast Sign, Inc., And shall not be reproduced, used by or disclosed to any firm or corporation for any purpose whatsoever without written permission.

No.	Designer	Date	Revision Notes	No.	Designer	Date	Revision Notes
13	JU	09-29-25	Add Raceway to Sign A, Relocate C, Added Sign H	7		01-07-25	Updated Parking Sign
16	IA	10-20-25	Update BB as per request	8	ER	08-21-25	Change Photo Sign C and E
17	WA	11.19.25	Update sign C & F	9	JU	08-26-25	Add ATM Surround to Brand Book
18	JU	11-26-25	Deleted Sign C from Brand Book	10	JU	09-09-25	Remove D, C no R.w. replace photo page 4
5				11	EA	09-23-25	Removed C added sign G
6				12	ER	09-25-25	Add Sign G

**DESIGN DRAWING 7 of 8**  
Request Number:  
**PRJ-WAFD-183240-R18**

**G FC.1 LOBBY ID STACKED LOGO - INTERIOR FLAT CUT LETTERS**

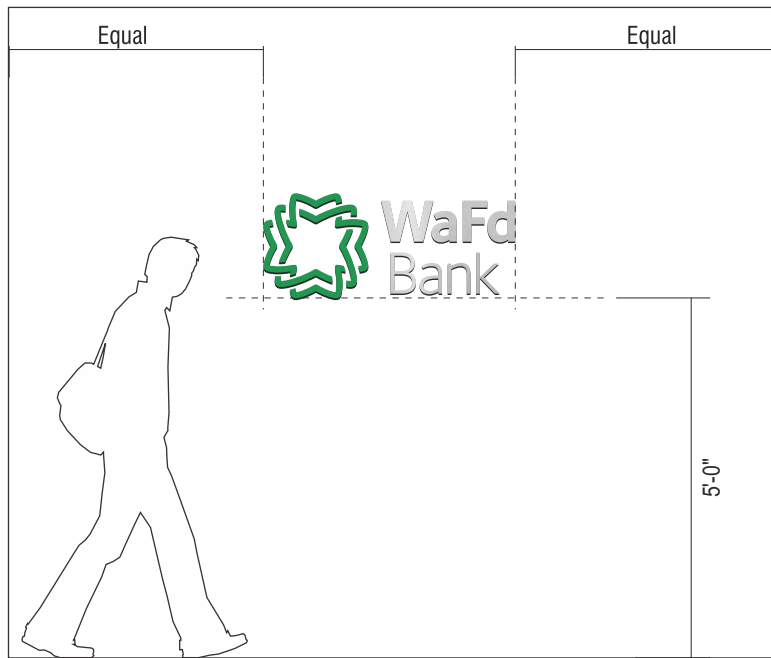

**PROPOSED**  
SCALE: 3/8" = 1'-0"

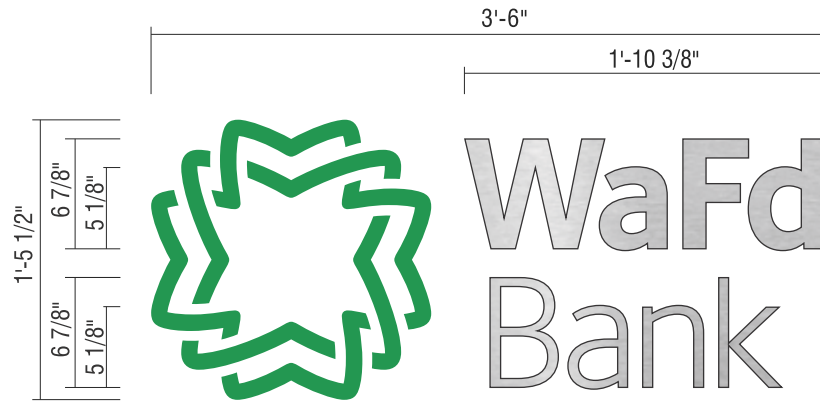

**FRONT VIEW**  
SCALE: 1" = 1'-0"



**SIDE VIEW**  
SCALE: 1" = 1'-0"

**SPECIFICATIONS**

- 1/2" THK. FLAT CUT BLACK SINTRA LETTERS
- LOGO FACES **V-2**, LETTER FACES **M-1**
- MECHANICALLY FASTEN FLUSH TO WALL

**COLORS/FINISHES**

- M-1** BRUSHED ALUM. FINISH HORIZ. GRAIN (WRISCO BRIGHT BRUSHED CLEAR)
- V-2** OPAQUE TO MATCH PANTONE 356C, VIVID GREEN 3630-156

**NOTES**

**COAST SIGN**  
1500 W. Embassy St. Anaheim, CA 92802 714.520.9144

Date: 09-25-2023	Project Name: WaFd Bank	Sit ID: Mercer Island
Scale: NTS	Address: 7633 SE 27TH ST	
Drawn: ER	City / State / Zip: MERCER ISLAND, WA	
PM: NC	Notes:	

This is an original unpublished drawing created by Coast Sign, Inc. It is submitted for your personal use in conjunction with a project being planned for you by Coast Sign, Inc., And shall not be reproduced, used by or disclosed to any firm or corporation for any purpose whatsoever without written permission.

No.	Designer	Date	Revision Notes	No.	Designer	Date	Revision Notes
13	JU	09-29-25	Add Raceway to Sign A, Relocate C, Added Sign H	7		01-07-25	Updated Parking Sign
16	IA	10-20-25	Update BB as per request	8	ER	08-21-25	Change Photo Sign C and E
17	WA	11.19.25	Update sign C & F	9	JU	08-26-25	Add ATM Surround to Brand Book
18	JU	11-26-25	Deleted Sign C from Brand Book	10	JU	09-09-25	Remove D, C no Rw, replace photo page 4
5				11	EA	09-23-25	Removed C added sign G
6				12	ER	09-25-25	Add Sign G

**DESIGN DRAWING 8 of 8**





Request Number:

**PRJ-WAFD-183240-R18**

**GENERAL SPECIFICATIONS:**

FACES: LOGO: .125" PAINTED ALUMINUM SHEET ROUTED FOR .750" CLEAR ACRYLIC w/ 1st SURFACE TRANSLUCENT VINYL w/ 2nd SURFACE DIFFUSER FILM PUSH-THRU GRAPHICS.  
 LETTERS: TRIMLESS .500" WHITE #7328 ACRYLIC  
 RETURNS: .063" PRE-PAINTED ALUMINUM COIL P/M PANTONE #3305C  
 BACKS: LOGO: .090" ALUMINUM SHEET  
 LETTERS: 3mm PRE-PAINTED ACM SHEET  
 ILLUMINATION: PRISM 24V MINI 6500K WHITE LED MODULES  
 RACEWAY: 3" x 5" ALUMINUM EXTRUDED RACEWAY (HIDDEN BEHIND WALL)

**COLOR SPECIFICATIONS:**

-  PAINT: PANTONE #3305C DARK GREEN, SATIN FINISH
-  VINYL: 3M #3630-156 GREEN TRANSLUCENT
-  ACRYLIC #7328 WHITE
-  PAINT: SHERWIN WILLIAMS #7040, SATIN FINISH

**GENERAL NOTES:**

- 1.) THIS SIGN IS INTENDED TO BE INSTALLED IN ACCORDANCE WITH THE REQUIREMENTS OF ARTICLE 600 OF THE NATIONAL ELECTRICAL CODE AND/OR OTHER APPLICABLE LOCAL CODES. THIS INCLUDES PROPER BONDING & GROUNDING OF THE SIGN
- 2.) BRANCH CIRCUIT:
  - A.) ALL BRANCH CIRCUITS FOR SIGNS MUST BE TOTALLY DEDICATED TO SIGNS (INCLUDING DEDICATED GROUND AND DEDICATED NEUTRAL PER CIRCUIT).
  - B.) SIGN CIRCUITS MUST NOT BE SHARED WITH OTHER LOADS SUCH AS LIGHTING, AIR CONDITIONING AND OTHER EQUIPMENT.
  - C.) PROPERTY SIZED GROUND WIRE THAT CAN BE TRACKED TO THE BREAKER PANEL MUST BE PROVIDED.
- 3.) U.L. AND DATA LABELS REQUIRED
- 4.) SIGN LABEL TO INDICATE SIGN SUITABLE FOR WET, DAMP, OR DRY LOCATION
- 5.) SIGN SATISFIES ALL REQUIREMENTS OF TITLE 24.
- 6.) OUTDOOR SIGNAGE TO EMPLOY EITHER PHOTOCELL OR OUTDOOR ASTRONOMICAL TIMER

**ELECTRICAL SPECIFICATIONS:**

(75) PRISM 24 MINI 6500K WHITE LED MODULES (701269-6W24SJ1-MB)= 30' 0"  
 (1) ENERGIZER SERIES 24V/60-WATT POWER SUPPLY (P-OH060-24-EC)  
 CUSTOMER PROVIDED 120V/20A/60Hz  
 DEDICATED CIRCUIT REQUIRED

**TOTAL CIRCUIT LOAD:**  
**1.35AMPS @ 120VAC**

**SIGN ATTACHMENT DETAIL (TYP.):**

HIDDEN 3" X 5" X .125" ALUMINUM EXTRUDED RACEWAY FABRICATED FROM .090" ALUMINUM. RACEWAY MOUNTED BEHIND WALL PANEL USING 3/8" X 3" ZINC-PLATED LAG SCREWS WITH 3/8" X 2-1/2" LAG SHIELD ANCHORS AND FLAT WASHERS, SPACED 16" O.C. TYPICAL. FASTENERS TO BE ANCHORED INTO STRUCTURAL BLOCKING OR METAL STUDS (NOT JUST CLADDING). ALL PENETRATIONS SEALED WATERTIGHT. SEE WALL ATTACHMENT DETAIL ON SHEET 2.



**SIDE VIEW**

**1** FACE LIT CHANNEL LETTERS w/ HIDDEN RACEWAY  
 Scale: 1"=1'-0"

**MFG TO INSTALL PICK-UPS AS REQUIRED**

As Primary Project Manager by my Signature I acknowledge that I have read and approve that the content and specifications of this document are accurate and ready for release to Production for Fabrication

Date \_\_\_\_\_

<b>COAST SIGN</b> 1500 W. Embassy St. Anaheim, CA 92802 714.520.9144	Date: 10/13/2025	Project Name: WAFD BANK - MERCER ISLAND, WA	This is an original unpublished drawing created by Coast Sign, Inc. It is submitted for your personal use in conjunction with a project being planned for you by Coast Sign, Inc., and shall not be reproduced, used by or disclosed to any firm or corporation for any purpose whatsoever without written permission.	No.	Engineer	Date	ECO Description	<b>ENGINEERING DWG. 1 of 4</b>  Product Number: <b>WAFD-CLRA-00008</b>  File Location: W:\WAFD BANK\ENGINEERING\ ECO Level: 0000
	Scale: NOTED	Coast Sign Description (short): 18" ILLUMINATED CHANNEL LETTERS ON HIDDEN RACEWAY						
Drawn: STEVE JOHNSON	Customer Description (if applicable):	Client Approval:						
Sales: YOUNG REY CHA		Date:						

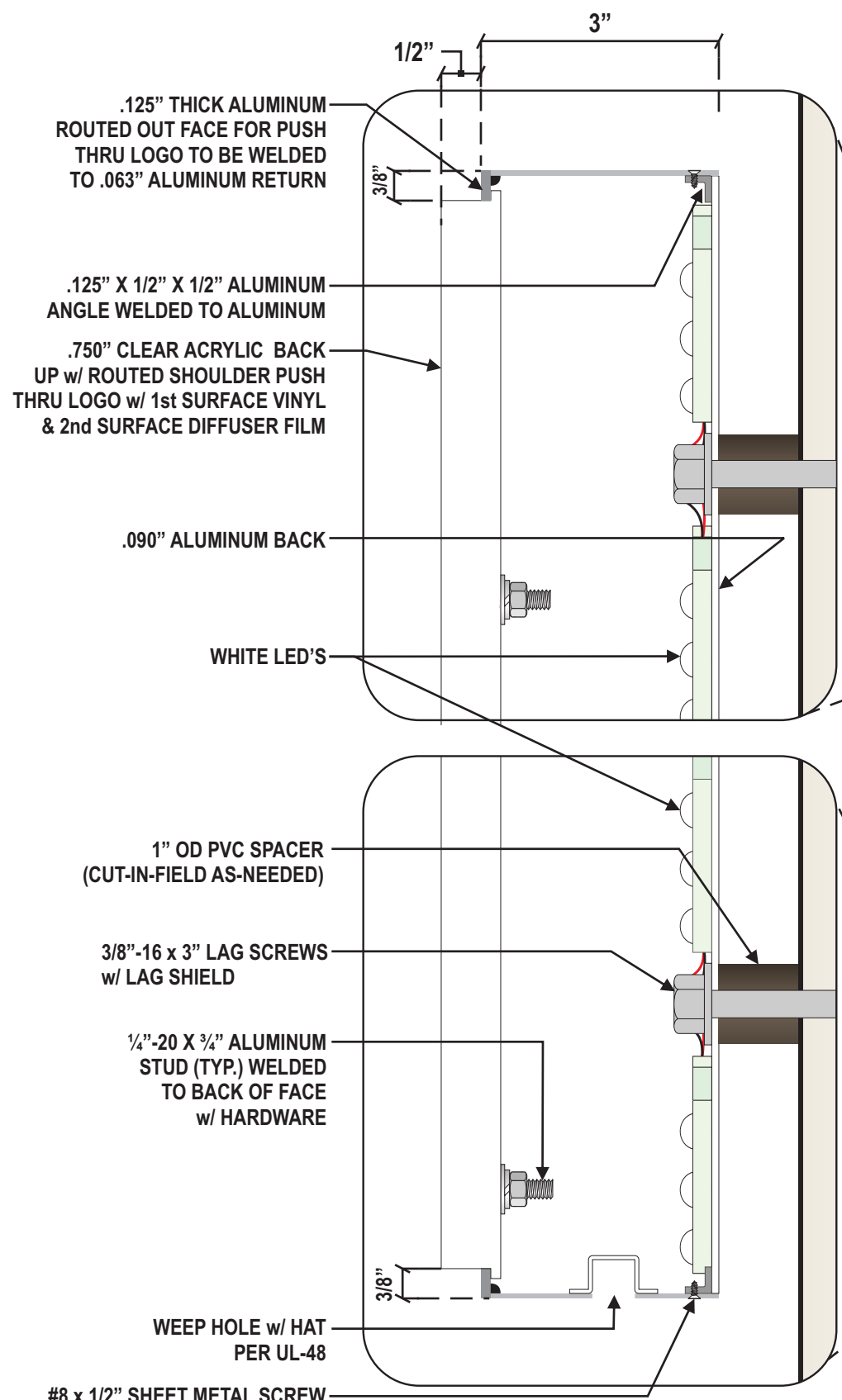

**1**  
**2** BLOW UP SECTION DETAIL  
Scale: 6"=1'-0"

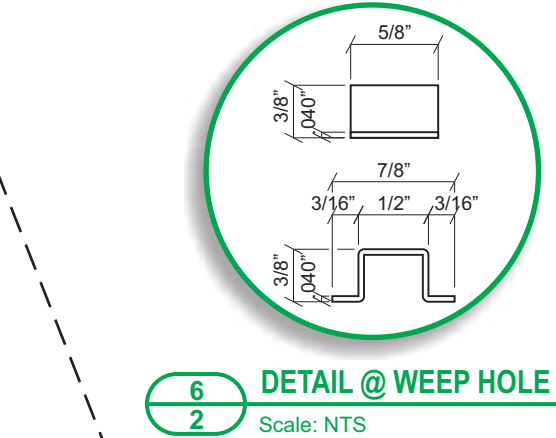

**6**  
**2** DETAIL @ WEEP HOLE HAT  
Scale: NTS

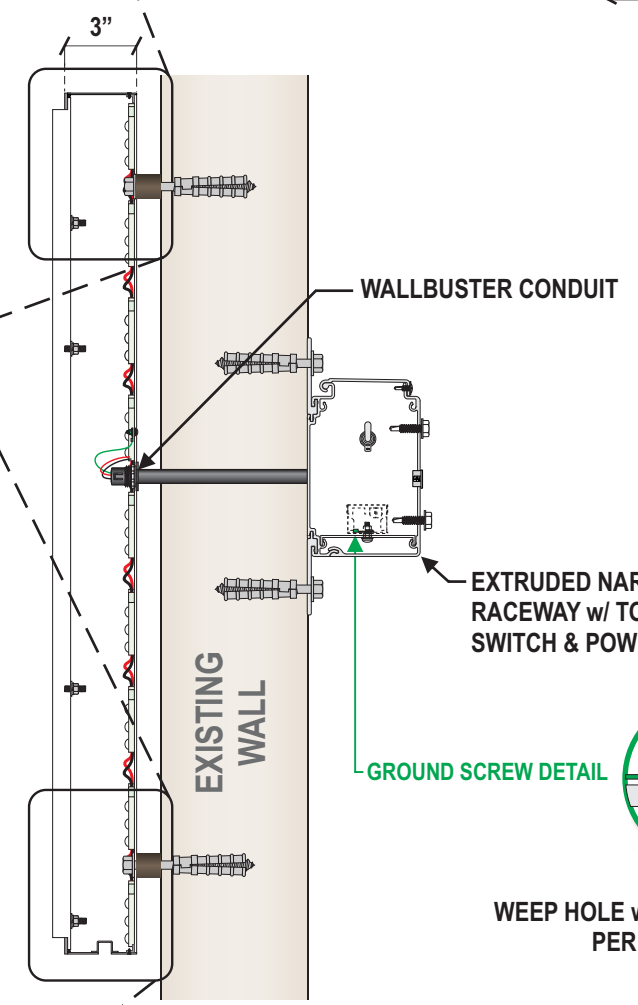

**2**  
**2** SECTION DETAIL- PUSH THRU CH/LOGO  
Scale: 1-1/2"=1'-0"

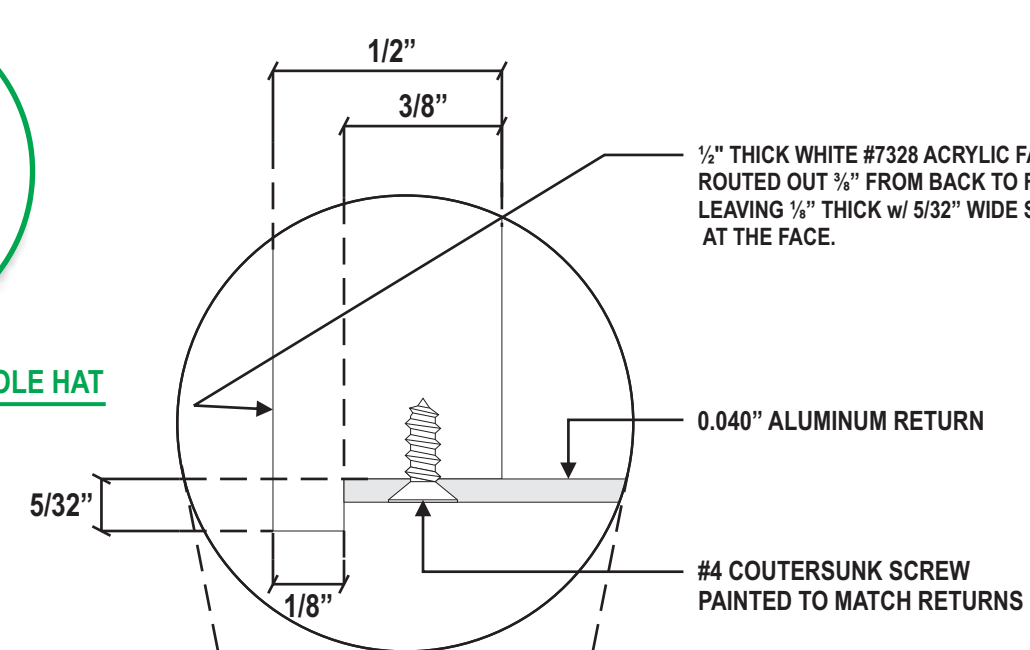

**5**  
**2** BLOW UP DETAIL  
Scale: NTS

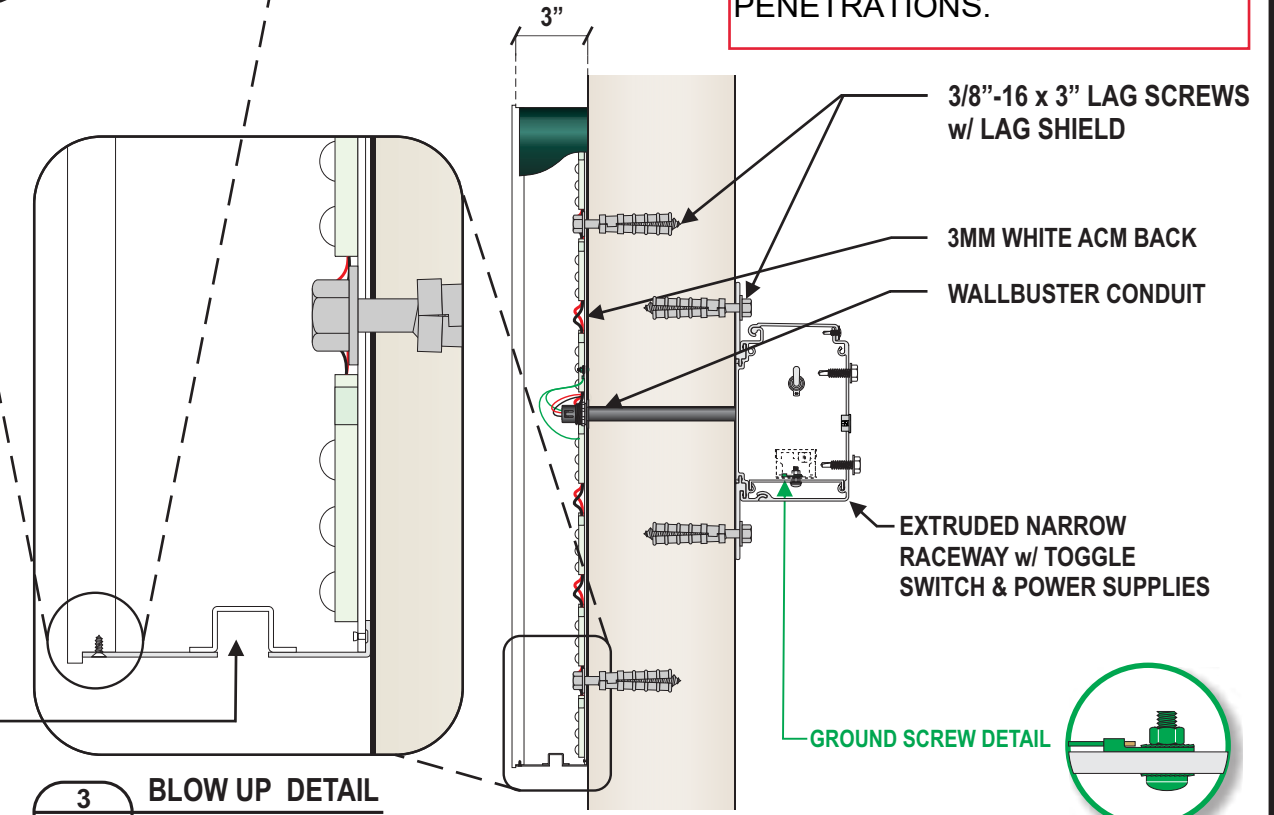

**3**  
**2** BLOW UP DETAIL  
Scale: 6"=1'-0"

**4**  
**2** SECTION DETAIL-TRIMLESS CH/LTRS  
Scale: 1-1/2"=1'-0"

FASTENERS: 3/8" X 3"

HEX-HEAD LAG SCREWS W/ 3/8" X 2-1/2"

LAG SHIELD ANCHORS & FLAT WASHERS @ 16" O.C. INTO STRUCTURAL BLOCKING / METAL STUDS.

RACEWAY = .090" ALUMINUM BACK. SEAL ALL PENETRATIONS.

Date: 10/13/2025	Project Name: WAFD BANK - MERCER ISLAND, WA
Scale: NOTED	Coast Sign Description (short): 18" ILLUMINATED CHANNEL LETTERS ON HIDDEN RACEWAY
Drawn: STEVE JOHNSON	Customer Description (if applicable):
Sales: YOUNG REY CHA	Client Approval: _____ Date: _____

This is an original unpublished drawing created by Coast Sign, Inc. It is submitted for your personal use in conjunction with a project being planned for you by Coast Sign, Inc., And shall not be reproduced, used by or disclosed to any firm or corporation for any purpose whatsoever without written permission.

No.	Engineer	Date	ECO Description
1			
2			
3			
4			
5			
6			

**ELECTRICAL SPECIFICATIONS:**  
 (75) PRISM 24 MINI 6500K WHITE LED MODULES (701269-6W24SJ1-MB)= 30' 0"  
 (1) ENERGIZER SERIES 24V/60-WATT POWER SUPPLY (P-OH060-24-EC)  
 CUSTOMER PROVIDED 120V/20A/60Hz  
 DEDICATED CIRCUIT REQUIRED  
**TOTAL CIRCUIT LOAD:**  
**1.35AMPS @ 120VAC**

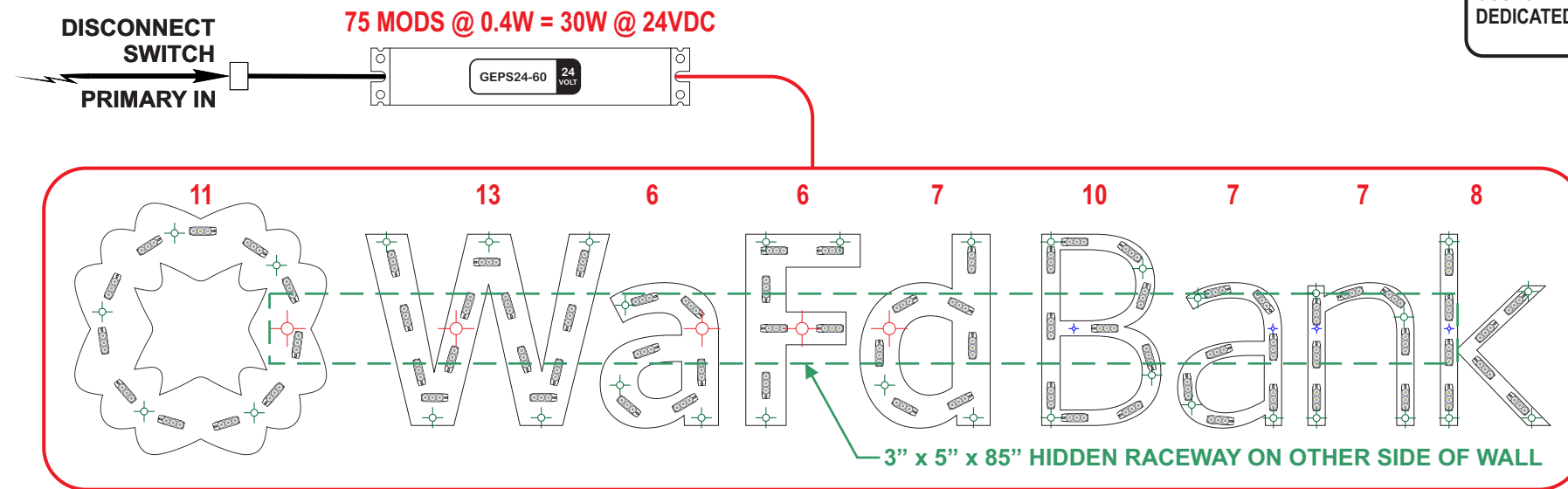

**1**  
**3** FRONT VIEW @ ELECTRICAL WIRING DIAGRAM  
 Scale: 1" = 1'-0"

Ø.875" ELEC. HOLE	Ø.250" ELEC. HOLE	Ø.500" MOUNTING HOLE
-------------------------	-------------------------	----------------------------

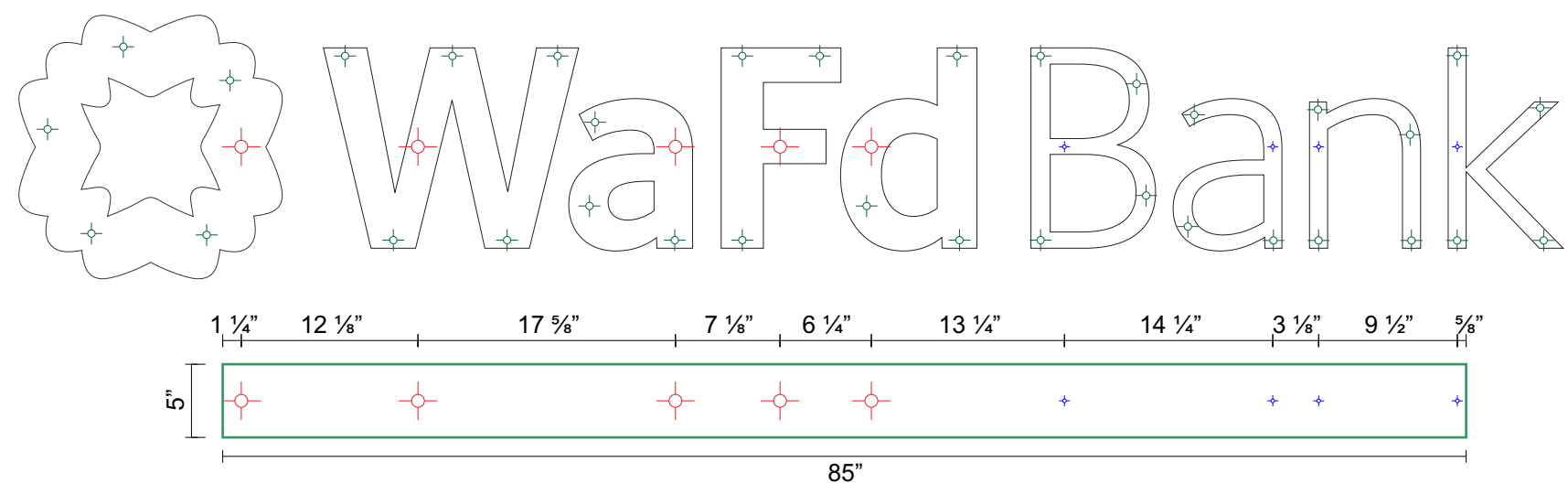

**2**  
**3** FRONT VIEW @ INSTALL PATTERN  
 Scale: 1" = 1'-0"

**COAST SIGN**  
 1500 W. Embassy St. Anaheim, CA 92802 714.520.9144

Date: 10/13/2025	Project Name: WAFD BANK - MERCER ISLAND, WA
Scale: NOTED	Coast Sign Description (short): 18" ILLUMINATED CHANNEL LETTERS ON HIDDEN RACEWAY
Drawn: STEVE JOHNSON	Customer Description (if applicable):
Sales: YOUNG REY CHA	Client Approval: _____ Date: _____

This is an original unpublished drawing created by Coast Sign, Inc. It is submitted for your personal use in conjunction with a project being planned for you by Coast Sign, Inc., And shall not be reproduced, used by or disclosed to any firm or corporation for any purpose whatsoever without written permission.

No.	Engineer	Date	ECO Description
1			
2			
3			
4			
5			
6			

**ENGINEERING DWG. 3 of 4**  
 Product Number:  
**WAFD-CLRA-00008**  
 File Location: W:\WAFD BANK\ENGINEERING\  
 ECO Level:  
**0000**



#	Part Number	Description	Qty	Units
1	ALPC00011	3MM X 48" X 96" WHITE ACM	0.26	EA
2	ALCO00078	.063" X 3.5" WHITE PRE-PAINTED ALUMINUM COIL	53.00	FT
3	ALSH00018	.125" X 4' X 8' MILL FINISH ALUMINUM SHEET 5052-H32	0.20	EA
4	ALSH00010	.090" X 4' X 8' MILL FINISH ALUMINUM SHEET 5052-H32	0.20	EA
5	ACSH00025	.750" X 48" X 96" CLEAR ACRYLIC SHEET	0.08	EA
6	ACSH00086	.500" X 48" X 96" WHITE #7328 ACRYLIC SHEET	0.26	EA
7	VILI00004	48" 3M #3635-70 DIFFUSER WHITE 65% LIGHT MANAGEMENT FILM	0.50	FT
8	VITR00044	48" 3M #3630-156 VIVID GREEN TRANSLUCENT VINYL	0.50	FT
9	EILD01319	SLOAN PRISM 24 MINI WHITE 6500K LED MODULES	30.00	FT
10	HEWI00047	MULTI CORE RED AND BLACK JACKETED WIRE 14 AWG -CL3P	100.00	FT
11	HMSC00176	#4 X 3/8" PHILLIPS FLAT HEAD SHEET METAL SCREW ZINC-PLATED	110.00	EA
12	PAXX00160	PAINT	0.05	QT
13	HXXX00004	33SW WHITE SILICONE SEALANT	1.00	EA
14	HMSC00089	1/4"-20 X 3/4" ALUMINUM WELD STUD	12.00	EA
15	HMWA00005	1/4" SAE FLAT WASHER (ZINC)	12.00	EA
16	HMNU00010	1/4"-20 HEX NUT (ZINC)	12.00	EA
<b>Raceway</b>				
17	ALCH00018	3 X .5 X .125 CHANNEL 6063-T52	7.08	FT
18	ALSH00010	.090" X 4' X 8' MILL FINISH ALUMINUM SHEET 5052-H32	0.13	EA
19	HMSC00073	#8 X 1/2" PHILLIPS FLAT HEAD SHEET METAL SCREW ZINC-PLATED	24.00	EA
20	PAXX00140	WHITE EPOXY PRIMER BASE EP-210W	0.09	QT
21	PAXX00160	PAINT	0.16	QT
22	EIPS00160	PRINCIPAL P-OH060-24-EC POWER SUPPLY	1.00	EA
23	HESW00003	20A/ 125-277V TOGGLE AND RUBBER BOOT	1.00	EA
<b>UL Required Materials</b>				
24	HEWI00002	12 GA (.109) STRANDED GREEN WIRE COIL	12.00	FT
25	HEWI00027	10-12 X 1/4" RING TERMINAL, GREEN PLATED	2.00	EA
26	HMNU00042	HARD MECH- 10-24 NUT W/STAR WASHER, GREEN PLATED	2.00	EA
27	HMSC00168	10-24-1/2" PAN PHILLIPS HEAD W/STAR WASHER, GREEN PLATED	2.00	EA
<b>Installation Materials</b>				
28	HMSC00141	3/8" X 3" HEX-HEAD LAG SCREW (ZINC)	44.00	EA
29	HMAN00011	3/8" X 2 1/2" LAG SHIELD ANCHOR	44.00	EA
30	HMWA00035	3/8" SAE FLAT WASHER (ZINC)	60.00	EA
31	STRTO0026	3/8"-1/8 IPS X 36" HOLLOW BRASS THREADED PIPE	2.00	EA
32	HMNU00098	3/8" BRASS HEXAGON LOCKNUT (1/8 IPS)	16.00	EA
33	HECO00087	14" WALLBUSTER PASS THRU CONDUIT	5.00	EA
34	PVPI00016	3/4" X 2" LG WHITE NYLON SPACER	4.00	EA
35	HXXX00005	HARD MISC- SILICONE SEALANT "CLEAR" 33SC	1.00	EA

ITEM #28-29: 3/8" X 3" LAG SCREW & 3/8" X 2-1/2" LAG SHIELD ANCHOR — USED FOR RACEWAY ATTACHMENT @ 16" O.C. INTO BLOCKING/STUDS.

1 MATERIAL USAGE  
4 Scale: 1/2"=1'-0"

FOR ESTIMATING PURPOSES ONLY

<h1>COAST SIGN</h1> <p>1500 W. Embassy St. Anaheim, CA 92802 714.520.9144</p>	Date: 10/13/2025	Project Name: WAFD BANK - MERCER ISLAND, WA	This is an original unpublished drawing created by Coast Sign, Inc. It is submitted for your personal use in conjunction with a project being planned for you by Coast Sign, Inc., And shall not be reproduced, used by or disclosed to any firm or corporation for any purpose whatsoever without written permission.	No.	Engineer	Date	ECO Description	<b>ENGINEERING DWG. 4 of 4</b> Product Number: <b>WAFD-CLRA-00008</b> File Location: W:\WAFD BANK\ENGINEERING\ ECO Level: <b>0000</b>
	Scale: NOTED	Coast Sign Description (short): 18" ILLUMINATED CHANNEL LETTERS ON HIDDEN RACEWAY		1				
	Drawn: STEVE JOHNSON	Customer Description (if applicable):		2				
	Sales: YOUNG REY CHA	Client Approval: _____ Date: _____		3				
			4					
			5					
			6					